

Product Specification for Approval

产品承认书

WE ARE PLEASED IN SUBMITTING OUR SAMPLES WITH SPECIFICATION TO YOU FOR APPROVAL.

很荣幸提供我们的样品规格给您承认。

CUSTOMER	:	
客户	:	盟创
DESCRIPTION	:	
描述	:	12V2A 欧规电源适配器
MODEL NO.	:	
铭普型号	:	MAES-1202003000
MNC P/N	:	
铭普料号	:	MC3000-EX-00
REVISION	:	
版本	:	A0
CUSTOMER P/N	:	
客户料号	:	
ISSUED DATE	:	
发行日期	:	2023/1/12
WEIGHT	:	
重量	:	
MADE IN:	:	
制造产地	:	CHINA

APPROVED BY MNC 铭普核准			APPROVED BY CUSTOMER 客户核准	
PREPARE 拟制	CHECKER 审核	APPROVE 批准	SIGNATURE OR STAMP 签字或盖章	
潘红	潘莹安	王瑞博		



1. PLEASE SEND BACK US A COPY OF THE SPECIFICATION WITH YOUR STAMP OR SIGNATURE ONCE THE SAMPLES APPROVED.

承认样品后请回传给我们一份盖章或签字的规格书。

2. IT WILL BE DEEMED THE SAMPLES TO BE APPROVED IF NO FEEDBACK.

如无反馈将默认为样品已被承认。

东莞铭普光磁股份有限公司
Dongguan Mentech Optical & Magnetic Co.,Ltd.
广东省东莞市石排镇东园大道石排段157号
No.157 Dongyuan Av, Shipai Town, Dongguan
City, Guangdong Province, P.R. CHINA
Tel/电话: (+86) 769-8692 1000
Fax/传真: (+86) 769-8170 1563

江西铭普电子有限公司
Jiangxi Mentech Electronics Co. Ltd
江西省抚州市广昌县莲爽大道中广电子信息产业园
A幢厂房
Building A, Zhongguang Electronic Information
Industrial Park, Lianshuang Avenue, Guangchang
County,Fuzhou City,Jiangxi Province,China
Tel/电话: (+86) 794-3610 8888

越南铭普电子股份公司
Mentech Electronics Vietnam Joint Stock Company
越南永福省平川县道德镇平川工业区
Binh Xuyen Industrial Park, Dao Duc Town, Binh
Xuyen County, Vinh Phuc Province,VIETNAM
Tel/电话: (+84) 21 -1388 8966



CHANGE RECORDS

变更记录

P/N 料号	REV. 版本	Description of Change 变更内容	Date 日期
MC3000-EX-00	A0	FIRST ISSUE 初版发行	2023/1/12

Contect 目录

1. SUMMARY 产品概述..... 4

2. INPUT CHARACTERISTICS 输入特性..... 4

3. DC OUTPUT CHARACTERISTICS 输出特性..... 4

4. ELECTRO MAGNETIC COMPATIBILITY 电磁兼容..... 6

5. SAFETY STANDARD 安规标准..... 7

6. ENVIRONMENTAL PERFORMANCES 环境性能..... 7

7. RELIABILITY 可靠性..... 7

8. MECHANICAL 机械性能..... 8

附件一、 LABEL 铭牌..... 9

附件二、 STRUCTURE AND DIMENSION 结构尺寸规格..... 10

附件三、 PACKAGE 包装方式..... 11

料号	版本	日期
MC3000-EX-00	A0	2023/1/12

1. SUMMARY 产品概述



1.1 Description 类型

- Adapter-Wall Mount插墙式适配器 LED Driver LED电源
- Adapter-Desk-Top桌面式适配器 Charger充电器
- Open Frame裸板 Others其他

**1.2 The product should meet the RoHS and REACH
产品符合RoHS和REACH**

1.3 Class of equipment 安全等级

【The product image is for reference purpose. please subject to our available products.】
Class I Class II ClassIII Not Classified

【图片供参考，请以实物为准。】

2. INPUT CHARACTERISTICS 输入特性

Item 项目	Units 单位	Minimum 最小	Normal 额定值	Maximum 最大	Remark 备注
Input voltage 输入电压	Vac	90	100-240	264	-
Input Frequency 输入频率	Hz	47	50-60	63	-
Input Current 输入电流	A	-	-	0.8	at 100Vac/60Hz~240Vac/50Hz
Inrush Current 浪涌电流	A	-	-	-	No damage,cold start,at 240Vac input & 25°C

3. OUTPUT CHARACTERISTICS 输出特性

3.1 Output voltage and current 输出电压与电流

Rated output voltage 额定输出电压(V)	Rated output current 额定输出电流(A)	Output voltage range 输出电压范围(V)	Ripple & Noise 纹波噪声(mVpp)
+12	2	+11.4~+12.6	<150

Ripple & Noise:Measurement is done by 20MHz bandwidth oscilloscope and the output paralleled a 0.1uF ceramic capacitor and a 10uF aluminum electrolytic capacitor. (test condition: 25°C, rated input and rated output)
 纹波噪声:量测时示波器选用20MHz带宽限制，输出端并联0.1uF陶瓷电容与10uF铝电解电容。
 (测试条件：环境温度25°C，额定输入和额定输出)

Parameter 参数	Min current 最小电流	Rate current 额定电流	Peak load current 峰值负载电流	Test mode 测试模式
CC:12V	0 A	2A	-	CC
CV:-	-	-	-	-

3.2 Line/Load Regulation 线性/负载调整率

Output/ 输出	Load condition /负载条件		Load Regulation /负载调整率	Line Regulation /线性调整率
	Min Load	Max Load		
+12V	0.0A	2A	±5%	±5%

料号	版本	日期
MC3000-EX-00	A0	2023/1/12

3.3 Dynamic response 动态响应

The Dynamic output voltage range is rated output voltage ±10% ,The load of 25% to 75% and change at a rate of about 0.1A/usec and frequency of the dynamic load is 50Hz .

在动态负载变化速率 0.1A/usec，频率为50Hz，负载为25%~75%时，输出动态电压范围为额定输出电压的 ±10%。

3.4 Output overshoot 输出过冲

Overshoot voltage less than output voltage 10% at 100-240Vac rated input.

在额定输入100-240Vac条件下，输出过冲电压小于输出电压的 10%。

3.5 Turn on delay time 开机延迟时间

3 S max. @ 115Vac input & rated load.

开机延迟时间小于 3 S@115Vac&额定负载。

3.6 Rise time and Fall time 输出上升时间和下降时间

At rated load,Rise time shall be ≤100 mS;Fall time shall be ≤100 mS.

在额定负载下，输出上升时间 ≤100 mS；输出下降时间 ≤100 mS；

3.7 Hold up time 输出保持时间

5 mS min @230Vac/50Hz input & rated load.

在输入230Vac/50Hz &额定负载时输出保持时间最少 5 mS。

3.8 Efficiency 电源效率

Efficiency能效		DOE		ERP		Remark备注
		V	VI	V	VI	
Output voltage输出电压(V)	12	-	-	-	12	Burn-in 30 minutes &115Vac/60Hz,230Vac/50Hz
Output current输出电流(A)	2	-	-	-	2	
Output power输出功率(W)	24	-	-	-	24	
Efficiency电源效率(%)		-	-	-	86.20%	
10% Load Efficiency 10% 负载电源效率(%)		-	-	-	-	
No-load power consumption空载功耗(W)		-	-	-	0.1	

Note: the calculation formula is as follow

注：计算公式如下

		DOE		ERP	
		V	VI	V	VI
1W<Po ≤49W	>6V full load	$\cong 0.0626*\ln(Po) + 0.622$	$\cong 0.071*\ln(Po) - 0.0014*Po + 0.67$	$\cong 0.063\ln(Po) + 0.622$	$\cong 0.071*\ln(Po) - 0.0014*Po + 0.67$
	>6V 10% load	-	-	-	-
	≤6V full load	$\cong 0.075*\ln(Po) + 0.561$	$\cong 0.0834*\ln(Po) - 0.0014*Po + 0.609$	$\cong 0.075*\ln(Po) + 0.561$	$\cong 0.0834*\ln(Po) - 0.0014*Po + 0.609$
	10% load	-	-	-	-

3.9 Over Current Protection 过流保护

At 100-240Vac input, OCP rang is 2.2~4.0 A.

在输入电压100-240Vac 条件下过流保护范围为 2.2~4.0 A。

料号	版本	日期
MC3000-EX-00	A0	2023/1/12

3.10 Over Voltage Protection 过压保护

The power has the OVP function at the rated input voltage and could self-recovering when the fault condition is removed.

在额定输入电压下适配器有过压保护功能，当故障状态移除时能自我恢复。

3.11 Short Circuit Protection 短路保护

The input power shall decrease when the output rail short, the power supply shall no damage, and shall be self-recovery when the fault condition is removed.

当输出短路时,产品输入功率降低且不会损坏,当短路情况解除后,产品将会自动恢复正常。

3.12 Capacitance load test 容性负载测试

The power adapter shall be able to turn on and operate normally with the following capacitance.Capacitance load:2000uF,at input voltage 100~240Vac, CR model.

在额定输入电压100~240Vac范围内，适配器能在2000uF容性负载(CR模式下)能正常启动。

4. ELECTRO MAGNETIC COMPATIBILITY 电磁兼容

4.1 Radiated Emission 电磁辐射干扰

Test criteria(测试标准): EN55032/FCC Part 15, class B/ GB9254.

4.2 Conducted Emission 电磁传导干扰

Test criteria(测试标准): EN55032/FCC Part 15, class B/ GB9254.

4.3 Electrostatic Discharge(ESD) 静电抗扰

EN 55024:2010; IEC 61000-4-2:2008

Air Discharge(空气放电): ±8 KV

Contact Discharge(接触放电): ±4 KV

Performance Criteria(性能标准) B

4.4 Radio-Frequency Electromagnetic Field Amplitude Modulated(RS) 辐射抗扰

EN 55024:2010; IEC 61000-4-3:2006+A1+A2

80MHz to 2700MHz ;10V/m ;80% and 1.0kHz Modulation(level 3)

Performance Criteria(性能标准) A

4.5 Electrical Fast Transient/Burst (EFT) 电快速瞬变脉冲群

EN 55024:2010; IEC 61000-4-4:2004

Power line: ±1 KV

Performance Criteria(性能标准) B

4.6 Lightning Surge Attachment 雷击抗扰

EN 55024:2010; IEC 61000-4-5:2005

Differential mode standard(差模标准): ±6.0 KV

Common mode standard(共模标准): ±6.0 KV

Performance Criteria(性能标准) B

4.7 Radio-Frequency Continuous Conducted(CS) 传导抗扰

EN 55024:2010; EN61000-4-6:2008

0.15-80 MHz, 3V/m, 80% AM,1KHz

Performance Criteria(性能标准) A

4.8 Voltage Dips and Interruptions 电压跌落变化

EN 55024:2010; IEC 61000-4-11:2004

Voltage Dips, 30% reduction- 10ms, Performance Criterion(性能标准) B,

60% Reduction – 100ms, Performance Criterion(性能标准) C,

Voltage Interruptions>95% Reduction- 5000ms, Performance Criterion(性能标准) C.

料号	版本	日期
MC3000-EX-00	A0	2023/1/12

5. SAFETY STANDARD 安规标准

5.1 Safety 安规

Item 安规	Country 国家	Standard 标准	Certified Status 状况
CCC	China 中国	GB4943.1	-
CE	Europe 欧洲	EN62368-1	-
UL/cUL	America/Canada 美国/加拿大	UL62368-1	-
GS	Germany 德国	EN62368-1	-
PSE	Japan 日本	J62368-1	-
KCC	Korean 韩国	K62368-1	-
CB	Global 全球	IEC62368-1	-
TUV Mark	United Kingdom 英国	BS EN62368-1	-
SAA	Australia 澳大利亚	AS/NZS62368-1	-
-	-	-	-
-	-	-	-

5.2 HI-POT 耐压

Primary-to-Secondary: 3000Vac for 60 seconds, the leakage current 5 mA max.
 初级到次级:交流3000V持续60秒, 漏电流最大5 mA。

5.3 LEAKAGE CURRENT 漏电流

0.25 mA max. at 264Vac/50Hz input.
 输入264Vac/50HZ, 漏电流最大0.25 mA。

5.4 INSULATION RESISTANCE 绝缘阻抗

50 MΩ min, at primary to secondary add a 500Vdc test voltage.
 500Vdc,初级对次级最小 50 MΩ。

6. ENVIRONMENTAL PERFORMANCES 环境性能

6.1 Operating Ambient Temperature: -5°C to + 55 °C

使用环境温度: -5°C至 + 55 °C

6.2 Operating Ambient Relative Humidity:5% to 90%R.H

使用环境相对湿度: 5%至 90% R.H

6.3 Storage Temperature :-45°C to +75°C

储存温度: -45°C 至 +75°C

6.4 Altitude: Safe use of belowing the sea level 5000 m area.

适用于海拔 5000 米及以下地区安全使用。

7. RELIABILITY 可靠性

7.1 MEAN TIME BETWEEN FAILURE(MTBF) 平均无故障时间

The MTBF should not be less than 50000 hours at the temperature of 25°C.(BELLCORE TR-332)
 在25°C环境温度下平均无故障时间不小于 50000 小时。(BELLCORE TR-332)

料号	版本	日期
MC3000-EX-00	A0	2023/1/12

7.2 Drop test 跌落试验

The power was dropped from a height of (1.0 ± 0.01) m onto a 20mm plank, hitting it for 1 time/surface(6 surfaces in total),no mechanical damages or other failures, no electrical deterioration and other failures comparing to previous test condition.

适配器从 (1.0 ± 0.01) m处落下1次/面（共6面），落在20mm厚的木板上，实验后与实验前状态比较没有机械破损等不良状况，且不出现电器性能损坏。

8. MECHANICAL 机械性能

8.1 Connector type 接口类型

AC Input pin 输入插脚: EU 2PIN

DC Output wire 输出线材: 20AWG 2468 1.5m ; Plug 插头: 5.5*2.5*9.5mm I TYPE



料号	版本	日期
MC3000-EX-00	A0	2023/1/12

文档密级：重要

File Security Category:Signality

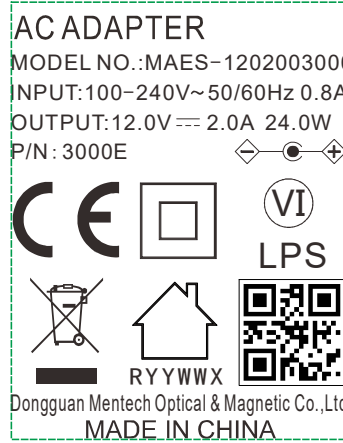
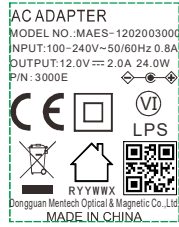

SCALE: 2:1

REV	DESCRIPTION	DWN	DATE
X0	NEW ISSUE	LZD	2023.01.13

公司LOGO及名称(Company): AC ADAPTER
 规格型号(Model No.): MODEL NO.: MAES-1202003000
 制造厂商(Manufacturer): Dongguan Mentech Optical & Magnetic Co.,Ltd.
 MADE IN CHINA
 P/N码(Serial No.): P/N:3000E
 P/N: 3000E
 A: 内部管控变量, A\B\C\D... A: Internal control variables, A\B\C\D...
 RYYWWX
 R:产品符合RoHS要求 R:Product meets RoHS
 YY:产品生产年份 YY:Year of production
 WW:产品生产周数 WW:Week of production
 X:代表产线线别 X:The line of production

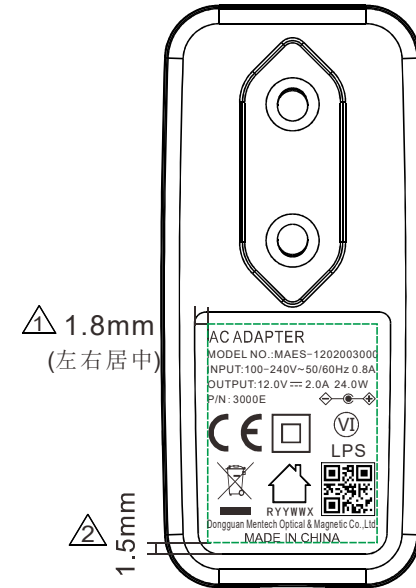

二维码内容：内部管控码

NOTES:

1. 作业方式：直接镭雕于产品表面一侧；
2. 字符实心体；
3. 镭雕前检查：镭雕前保持表面清洁，对位准确
4. 外观检测：铭牌边框不镭雕,无重影,笔画清晰一致,无发黑发黄,字符水平无偏斜；
5. 标注'△'为重点管控尺寸；
6. 标注'⊙'为变更标示；

安规尺寸(Safety symbol size):

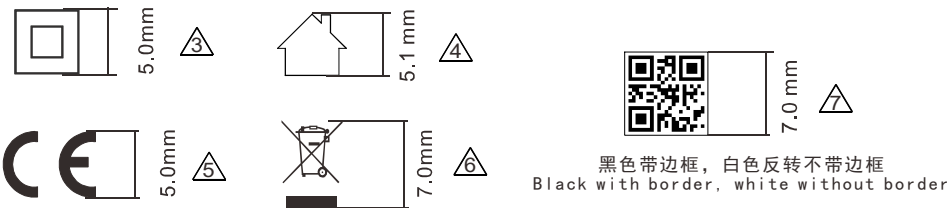

TOLERANCE LEVEL		mentech					
X.	±0.5	DWN:李镇东	PART NO: MC3000-EX-00				
.X	±0.2		TITLE: MC3000-EX-00镭雕说明				
.XX	—	CHKD:潘莹安		UNITS	SCALE	SHEET	REV.
.XXX	—	APPD:王瑞博		mm	1:1	1/1	X0

THESE DRAWINGS AND SPECIFICATIONS ARE THE PROPERTY OF MENTECH, INC./CO., LTD. AND SHALL NOT BE REPRODUCED, COPIED OR USED IN ANY MANNER WITHOUT THE PRIOR WRITTEN CONSENT OF MENTECH INC./CO., LTD.

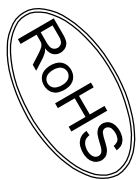

REV	DESCRIPTION	DWN	DATE
X0	NEW ISSUE	LZD	2023/01/13

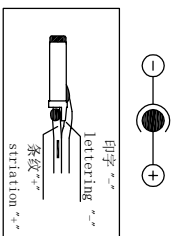
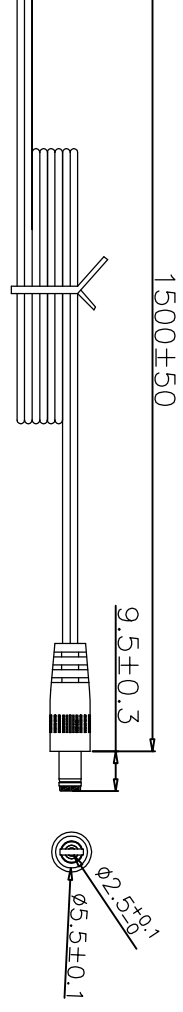
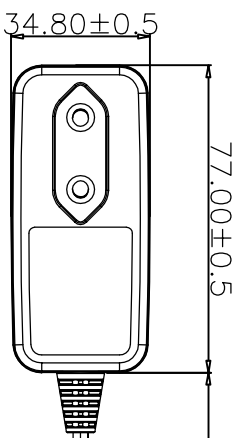
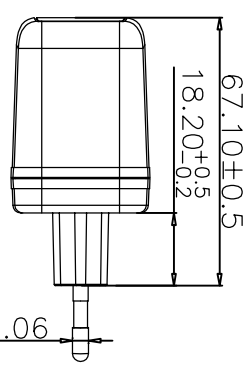
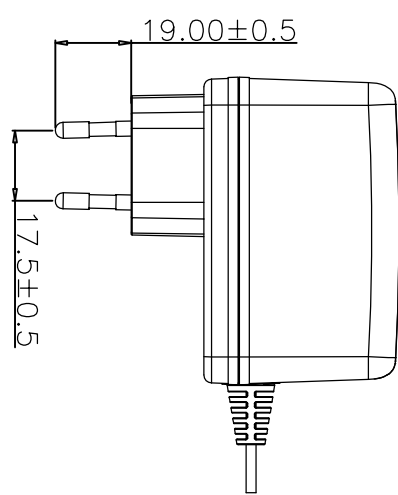

序号 NO.	材料 Material	材料规格 Material specification
1	线材 Wire	UL2468 20AWG 1.5M 黑色外被 UL2468 20AWG 1.5M Black
2	插头 Plug	5.5*2.5*9, 5mm, 音叉直头, 黑胶芯 5.5*2.5*9, 5mm, Groovefork I type plug, Black rubber core
3	外壳 Case	材质PC UL94-V0 颜色: 黑色, 插脚铜镀镍 Material of PC UL94-V0, White, Nickel plated copper.
4	单位 Unit	MM

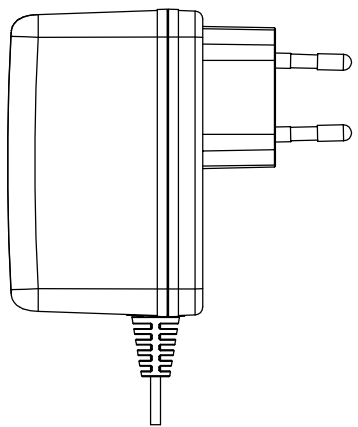

TOLERANCE LEVEL

K.	±0.5
.X	±0.2
.XX	±0.1
.XXX	±0.05
角度	±0.5°

mentech

DWVN:李镇东

APPD:王瑞博

PART_NO:MP3000-EX-00
TITLE:24W EU ADAPTER SPEC
UNITS: mm
SCALE: 1:1
SHEET: 1/1
REV: X0

THESE DRAWINGS AND SPECIFICATIONS ARE THE PROPERTY OF MENTECH AND SHALL NOT BE REPRODUCED, COPIED OR USED IN ANY MANNER WITHOUT THE PRIOR WRITTEN CONSENT OF MENTECH IND. CO., LTD.

REV	DESCRIPTION	DWN	DATE
A0	NEW ISSUE	WJSW	2018/12/19

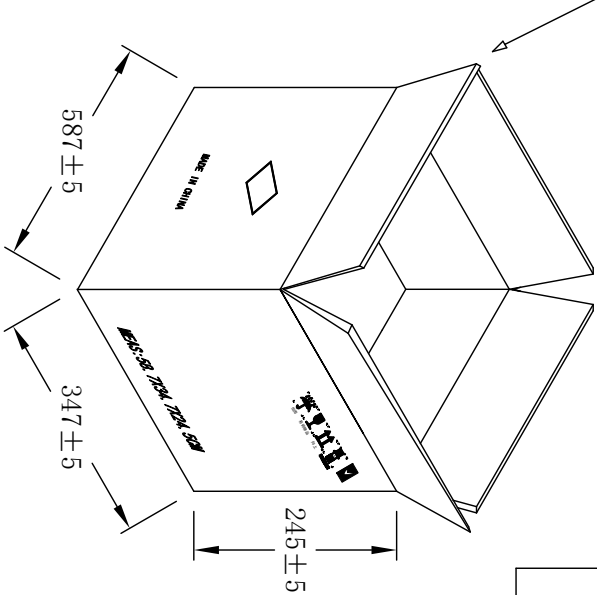
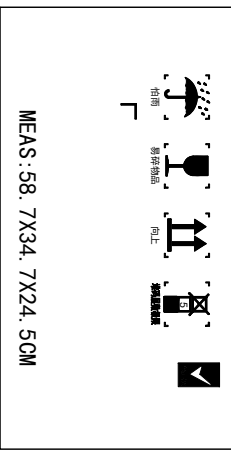
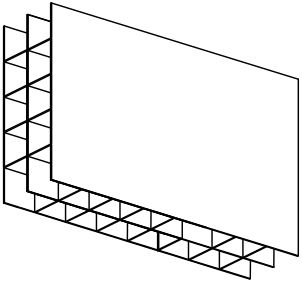
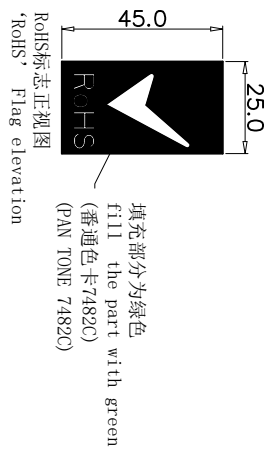
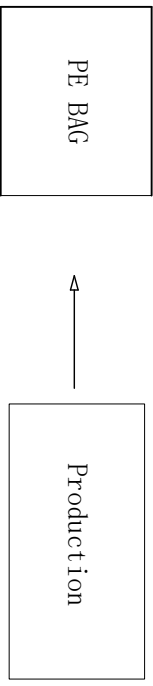

notes:
 1. each box 96PCS, 2 level in total
 2. put a flat card on each level
 3. product packaging: PE bag+knife cards

注:
 1. 每箱96PCS, 共2层.
 2. 每隔层放一张平卡.
 3. 产品包装: PE袋+刀卡.

TOLERANCE LEVEL	
厚度	±0.5
外形尺寸	±5.0
/	/
/	/
/	/

DWN: 万邵伟	Drawing_NO: P-M9-EU-00
CHKD: 严敏	TITLE: P-M9-EU-00 Packing
APPD: 王瑞博	UNITS: mm
	SCALE: 1:1
	SHEET: 1/1
	REV: A0

THESE DRAWINGS AND SPECIFICATIONS ARE THE PROPERTY OF MARENTECH IND.CO., LTD. ANY REPRODUCTION OR UNAUTHORIZED COPIED OR USED IN ANY MANNER WITHOUT THE PRIOR WRITTEN CONSENT OF MARENTECH IND. CO., LTD.