MPB2510-D0C-Cxx

Features

- ◆ Hot-pluggable SFP28 form factor
- ◆ Supports 24.33Gb/s~25.78Gb/s bit rate
- ◆ Uncooled CWDM (1271~1371nm) DFB Laser and PIN photo detector
- ◆ Maximum link length of 10km on SMF
- ◆ Duplex LC receptacle
- ◆ Operating case temperature range
Commercial:0~70°C
- ◆ Low power dissipation:
Commercial: < 1.2 W
- ◆ Single 3.3V power supply
- ◆ Class1 laser safety compliance

Applications

- ◆ 25G Ethernet
- ◆ eCPRI/CPRI-10
- ◆ Data center

Standards

- ◆ Compliant to SFP28 MSA
- ◆ Compliant with IEEE 802.3cc
- ◆ Compliant with SFF-8432, SFF-8472
- ◆ RoHS compliant

1. General Description

MPB2510-D0C-Cxx is a single-Channel, Pluggable, Fiber-Optic SFP28 for 25G Ethernet and 5G Wireless Applications. It is a high performance module which operates at 25.78Gbps up to 10km by single mode fiber. This module uses the duplex LC receptacle, which use uncooled CWDM (1271~1371nm) DFB Laser and PIN photo detector.

2. Absolute Maximum Ratings

It has to be noted that the operation in excess of any individual absolute maximum ratings might cause permanent damage to this module.

Parameter	Symbol	Min	Max	Unit
Storage Temperature	Ts	-40	+85	℃
Operating Humidity	RH	5	95	%
Supply Voltage	Vcc	-0.5	3.6	V

3. Recommended Operating Environment

Recommended Operating Environment specifies parameters for which the electrical and optical characteristics hold unless otherwise noted.

Parameter	Symbol	Min	Typical	Max	Unit	Notes
Operating Case Temperature	Tc	0	-	+70	℃	MPB2510-D0C-Cxx
Supply Voltage	Vcc	3.13	3.3	3.47	V	MPB2510-D0C-Cxx
Supply Current	Icc	-	-	360	mA	MPB2510-D0C-Cxx
Bit Rate	BR	24.33	-	25.78	Gb/s	±100ppm
Link Distance with ITU-T G.652.D rated fiber		-	-	10	km	

4. Optical Characteristics

The following Optical characteristics are defined over the Recommended Operating Environment unless otherwise specified.

Optical Transmitter Characteristics						
Parameter	Symbol	Min	Typical	Max	Unit	Notes
Operating Wavelength Range	λ_c	1264.5	1271	1277.5	nm	MPB2510-D0C-C27
		1284.5	1291	1297.5		MPB2510-D0C-C29
		1304.5	1311	1317.5		MPB2510-D0C-C31
		1324.5	1331	1337.5		MPB2510-D0C-C33
		1344.5	1351	1357.5		MPB2510-D0C-C35
		1364.5	1371	1377.5		MPB2510-D0C-C37
Spectral Width (-20dB)	$\Delta\lambda$	-	-	1	nm	
Sidemode Suppression ratio	SMSR	30	-	-	dB	
Average Launch Power	Pout	0	-	6	dBm	MPB2510-D0C-Cxx
Extinction Ratio	ER	3.5	-	-	dB	
Relative Intensity Noise	RIN	-	-	-130	dB/Hz	
Transmitter Reflectance		-	-	-26	dB	
Transmitter and Dispersion Penalty	TDP	-	-	3.5	dB	MPB2510-D0C-Cxx
Transmitter Eye mask definition {X1, X2, X3, Y1, Y2, Y3}		{0.31, 0.4, 0.45, 0.34, 0.38, 0.4}				1,2
Optical receiver Characteristics						
Parameter	Symbol	Min	Typical	Max	Unit	Notes
Lane center wavelengths(range)		1250	1310	1620	nm	
Receive Saturation (OMA) power	Rmax	2.2	-	-		
Unstressed Receiver Sensitivity(OMA)	Rxsen	-	-	-14	dBm	3,4,5
Receiver Reflectance		-	-	-26	dB	
LOS	Optical De-assert	Pd	-	-17	dBm	
	Optical Assert	Pa	-30	-		
LOS hysteresis		0.5	-	5	dB	

Notes:

1. Transmitter hit Ratio 5E-5 hits/sample, 1000 waveforms at typical rate and room temperature
2. Compliant with IEEE 802.3cc
3. Minimum value is informative, equals min Tx OMA with infinite ER and max channel insertion loss

4. Measured with a PRBS 2³¹-1 test pattern, @25.78Gb/s, BER<5E-5.
5. Power value and power accuracy are with TX on.

5. Electrical Characteristics

The following electrical characteristics are defined over the Recommended Operating Environment unless otherwise specified.

Parameter	Symbol	Min	Typ	Max	Unit	Notes
Supply Voltage	Vcc	3.13	3.3	3.47	V	
Transmitter						
Input differential impedance	Rin		100		Ω	1
Differential data input swing	Vin,pp	200	-	900	mV	
Transmit Fault Assert Voltage		2.4	-	Vcc+0.3	V	LVTTL
Transmit Fault Deassert Voltage		-0.3	-	+0.4	V	LVTTL
Transmit Disable Voltage		2	-	Vcc+0.3	V	LVTTL
Transmit Enable Voltage		0	-	0.8	V	LVTTL
Receiver						
Differential data output swing	Vout,pp	450	-	750	mV	2
LOS Assert Voltage		2.4	-	Vcc+0.3	V	LVTTL
LOS Deassert Voltage		-0.3	-	+0.4	V	LVTTL

Notes:

1. Connected directly to TX data input pins. AC coupled thereafter.
2. Into 100 ohms differential termination.

6. Digital Diagnostic Monitoring Information

Parameter	Accuracy	Calibration	Notes
Temperature	±3 °C	Internal	0 °C ~ 70 °C
Voltage	±3%	Internal	3.13 ~ 3.47V
Bias Current	±10%	Internal	Specified by normal value
TX Power	±3dB	Internal	0~ +6dBm
RX Power	±3dB	Internal	-14 ~ +2.2dBm

7. Pin Assignment

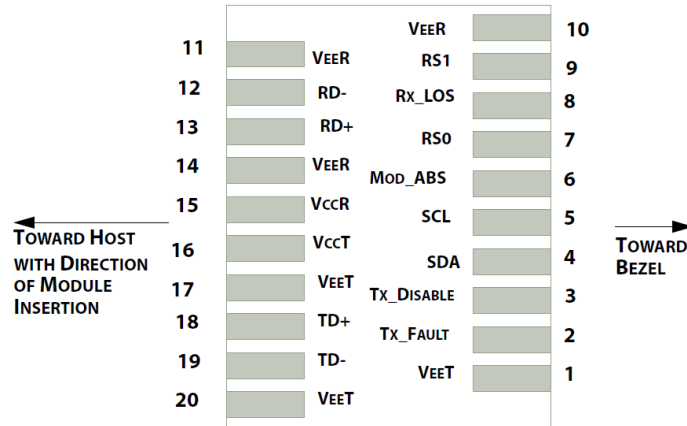

Figure1 SFP28 Pad assignment Top View

Pin	Symbol	Name/Description	Power Seq.	Notes
1	VeeT	Transmitter Ground	1st	1
2	TX_Fault	Transmitter Fault	3rd	2
3	TX_Disable	Transmitter Disable	3rd	3
4	SDA	2-Wire Serial Interface Data Line	3rd	4
5	SCL	2-Wire Serial Interface Data Line	3rd	4
6	Mod_ABS	Module Absent, Connect to VeeT or VeeR in Module	3rd	5
7	RS0	No connection required	3rd	6
8	RX_LOS	Receiver Loss of Signal indication	3rd	7
9	RS1	No connection required	3rd	8
10	VeeR	Receiver Ground	1st	1
11	VeeR	Receiver Ground	1st	1
12	RD-	Receiver Inverted DATA out. AC Coupled. CML-O	3rd	9
13	RD+	Receiver Non-inverted DATA out. AC Coupled. CML-O	3rd	9
14	VeeR	Receiver Ground	1st	1
15	VccR	Receiver Power Supply	2nd	10
16	VccT	Transmitter Power Supply	2nd	10
17	VeeT	Transmitter Ground	1st	1
18	TD+	Transmitter Non-Inverted DATA in. AC Coupled. CML-I	3rd	11
19	TD-	Transmitter Inverted DATA in. AC Coupled. CML-I	3rd	11
20	VeeT	Transmitter Ground	1st	1

Power Seq.: Pin engagement sequence during hot plugging.

Notes:

1. The module signal ground contacts.
2. This pin is an open drain/collector and should be pulled up to Vcc-host in the host with a 4.7k~10k Ohm resistor.
3. This pin should be pulled up to VccT with a 4.7k~10k Ohm resistor in modules.
4. SDA&SCL (IIC) are needed pull up 4.7k~10k Ohm resistors on host board.
5. Mod_ABS is connected to VeeT or VeeR in the SFP28 module.
6. Rate Select 0,no connection required.
7. Module RX_Los of signal indication need pull up 4.7k~10k Ohm resistor on host board.
8. Rate Select 1,no connection required.
9. RD -/+: These are the differential receiver outputs. They are CML AC-coupled with 100 Ohm terminal resistor matching internal.
10. VccR and VccT are the receiver and transmitter power supplies.
11. TD -/+: These are the differential transmitter inputs. They are CML AC-coupled with 100 Ohm terminal resistor matching internal.

8. EEPROM Memory Map

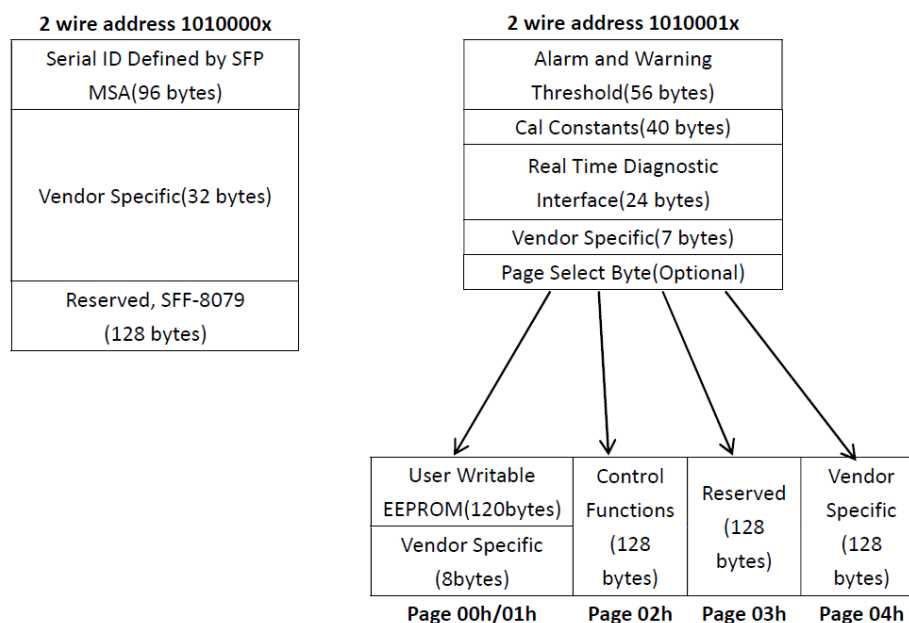
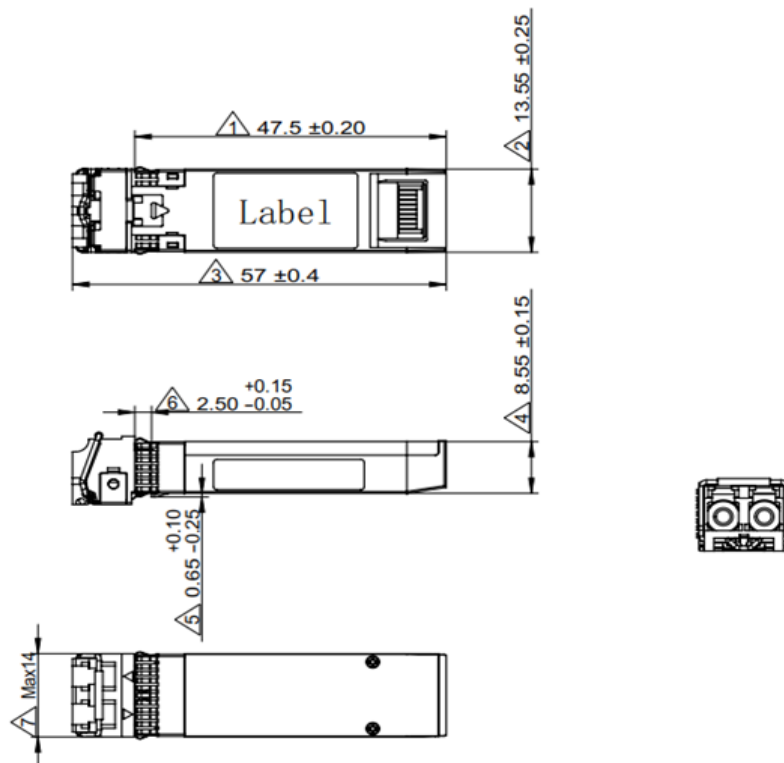

Figure 2 SFP28 Memory Map

Product Security requirements

Items	Contents
Virus scanning	Don't contain malicious code or code vulnerabilities such as Trojans, viruses, worms, backdoors, etc.
Source code static scanning	Don't contain dead pointers, divide by 0, integer overflow, invalid shift operations, memory management, null pointer indirect references, boundary overflow checks, uninitialized variables, write constants, etc.
Source code security scanning	Don't contain memory leaks, out of bounds errors, arithmetic errors, suspicious code, logic errors, etc.

9. Mechanical Drawing

Dimensions are in millimeters. (Unit: mm).



NOTE: Dimensions in the pictures are compliant with MSA.





The design above is only for Reference. Please contact MNC for more detail.

10. Ordering information

Part. No	Specifications								
	Form Factor	Data Rate (Gbps)	λ (nm)	Po (dBm)	RX	Sen* (dBm)	Reach (km)	Color	DDMI
MPB2510-D0C-C27	SFP28	25.78	1271	0~6	PIN	<-14	10	Water-Blue	Y
MPB2510-D0C-C29	SFP28	25.78	1291	0~6	PIN	<-14	10	Hot Pink	Y
MPB2510-D0C-C31	SFP28	25.78	1311	0~6	PIN	<-14	10	Olive	Y
MPB2510-D0C-C33	SFP28	25.78	1331	0~6	PIN	<-14	10	Yellow green	Y
MPB2510-D0C-C35	SFP28	25.78	1351	0~6	PIN	<-14	10	Sky-Blue	Y
MPB2510-D0C-C37	SFP28	25.78	1371	0~6	PIN	<-14	10	Pink	Y

Notes:

1. Measured with a PRBS 2³¹-1 test pattern, @25.78Gb/s, BER<5E-5.
2. Color display

SN	Wavelength	Color	Pantone	R	G	B	Color display
1	1271nm	Water-Blue	3245C	161	223	210	
2	1291nm	Hot Pink	Red U	198	82	158	
3	1311nm	Olive	581U	112	111	75	
4	1331nm	Yellow green	7488C	152	213	92	
5	1351nm	Sky-Blue	2925C	78	150	216	
6	1371nm	Pink	2385C	180	49	172	